



WHITE KNIGHT™

.....*simply driven™*

PX60 DIMENSIONALS

Pump Dimensions

DIMENSIONS IN [MILLIMETERS] INCHES

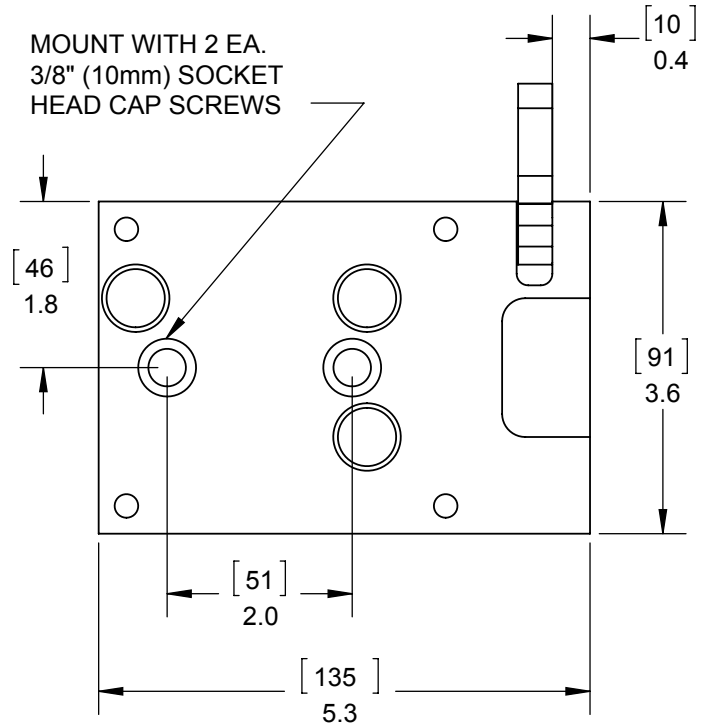
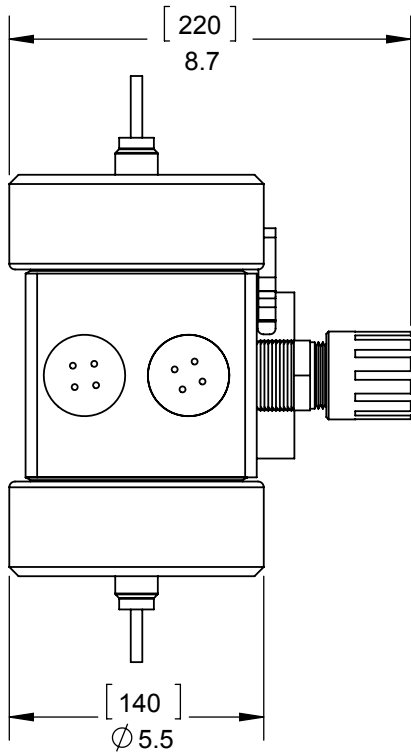

MOUNT WITH 2 EA.
3/8" (10mm) SOCKET
HEAD CAP SCREWS

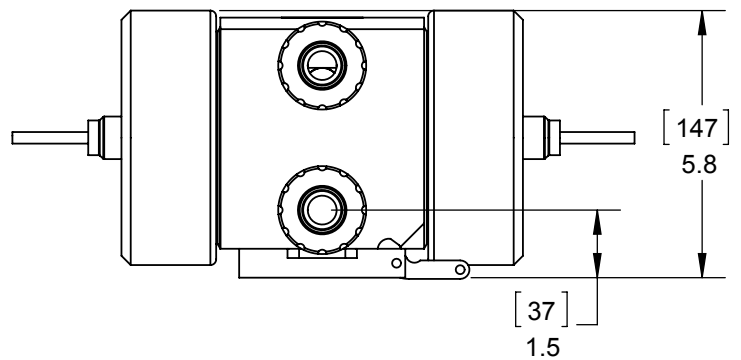
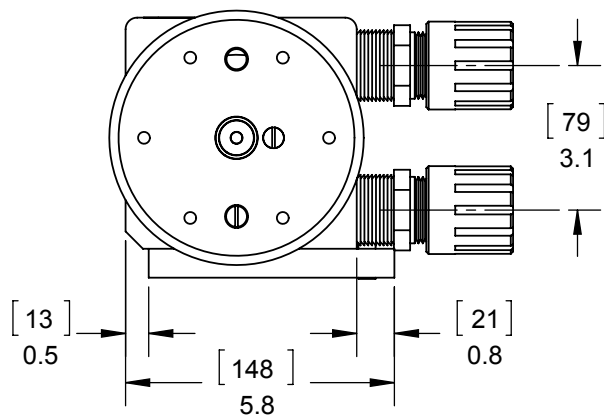

wkfluidhandling.com/px60

Our engineers are easy to work with and ready to perform your custom testing.
Contact us at info@wkfluidhandling.com or 435.783.6040, or visit wkfluidhandling.com

Published July 17, 2013 | All specifications are subject to change without notice.

© 2013 White Knight Fluid Handling, Inc.

