

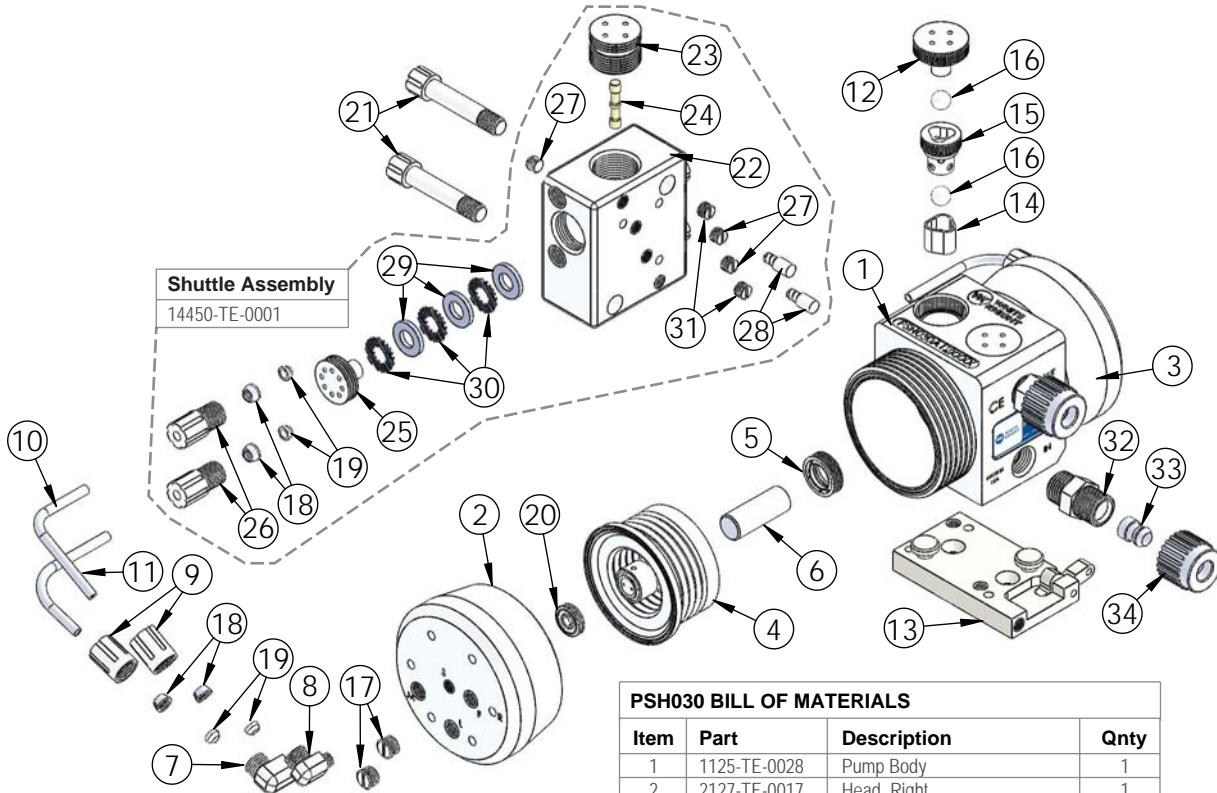







PSH015 Exploded View



PSH030 BILL OF MATERIALS

Fittings (Type, Size, Option)			Assemblies		Body Inlet Only (Nut not included)
	1/4 in.	F04	14510-PF-0016	7200-PF-0001	
	3/8 in.	F06	14510-PF-0001	7200-PF-0002	
	1/2 in.	F08	14510-PF-0002	7200-PF-0003	
	3/4 in.	F12	14510-PF-0003	7200-PF-0004	
	3/8 in.	T06	7120-PF-0001		
	1/2 in.	T08	7120-PF-0002		
	3/4 in.	T12	7120-PF-0003		
	1/2 in.	W08	7300-PF-0001		
	3/4 in.	W12	7300-PF-0002		
	1/8 in.	P02	TBD	7400-TE-0036	
	1/4 in.	P04	14530-PF-0025	7400-TE-0031	
	3/8 in.	P06	14530-PF-0012	7400-TE-0023	
	1/2 in.	P08	14530-PF-0001	7400-TE-0001	
	3/4 in.	P12	14530-PF-0002	7400-TE-0002	
	1/4 in.	N04	7100-TE-0001		
	3/8 in.	N06	7100-TE-0002		
	1/2 in.	N08	7100-TE-0003		
	3/4 in.	N12	7100-TE-0007		
	3/8 in.	S06	14520-TE-0009	7010-TE-0001	
	1/2 in.	S08	14520-TE-0001	7010-TE-0003	
	3/4 in.	S12	14520-TE-0002	7010-TE-0002	
	1/4 in.	L04	14570-PF-0013	7800-TE-0013	
	3/8 in.	L06	14570-PF-0014	7800-TE-0014	
	1/2 in.	L08	14570-PF-0001	7800-TE-0001	
	3/4 in.	L12	14570-PF-0002	7800-TE-0002	
Plugged		B00	7130-TE-0001		

Item	Part	Description	Qty
1	1125-TE-0028	Pump Body	1
2	2127-TE-0017	Head, Right	1
3	2127-TE-0018	Head, Left	1
4	14300-MP-0013	Bellows, Assembly	2
5	5143-MP-0001	Seal, Shaft	2
6	5144-PF-0024	Shaft	1
7	6030-TE-0004	Elbow, Gripper, 1/4" NPT x 1/4"	2
8	6030-TE-0001	Elbow, Gripper, 1/8" NPT x 1/4"	2
9	6070-TE-0001	Female Gripper Nut, 1/4"	4
10	10071-PF-0009	Tubing, 1/4"	2
11	10071-PF-0008	Tubing, Thick Wall, 1/4"	2
12	4140-TE-0001	Top Check Plug	2
13	14200-NP-0006	Plate, Base, Assembly	1
14	4135-MP-0006	Seat, Check	2
15	4142-MP-0004	Cage, Check	2
16	4100-MP-0004	Ball, Check, 1/2"	4
17	10040-TE-0003	Plug, NPT, 1/4"	4
18	6080-KF-0001	Gripper, 1/4"	8
19	6080-TE-0001	Ferrule, 1/4"	8
20	3133-TE-0006	Seat, Head, Shift	2
21	10010-TE-0017	Screw, Mount, Shuttle	2
22	14400-TE-0009	Body, Shuttle, With Sleeve	1
23	6530-TE-0001	Shuttle End Cap	2
24	6560-CE-0001	Shuttle Spool	1
25	6150-TE-0010	Cap, Muffler	2
26	6070-TE-0004	Male Gripper Nut, 1/4"	4
27	10040-TE-0002	Plug, NPT, 1/8"	3
28	10020-TE-0004	Pin, Alignment, Shuttle	2
29	6140-FP-0003	Baffle	6
30	6140-PP-0003	Spacer, Baffle	6
31	10040-TE-0015	Plug, Vent, NPT, 1/8"	2
32	7400-TE-0001	Body, S-300®, 1/2"	2
33	7400-PF-0001	Insert, S-300®, 1/2"	2
34	7400-PF-0005	Nut, S-300®, 1/2"	2

<https://wkfluidhandling.com/psh-series/>