

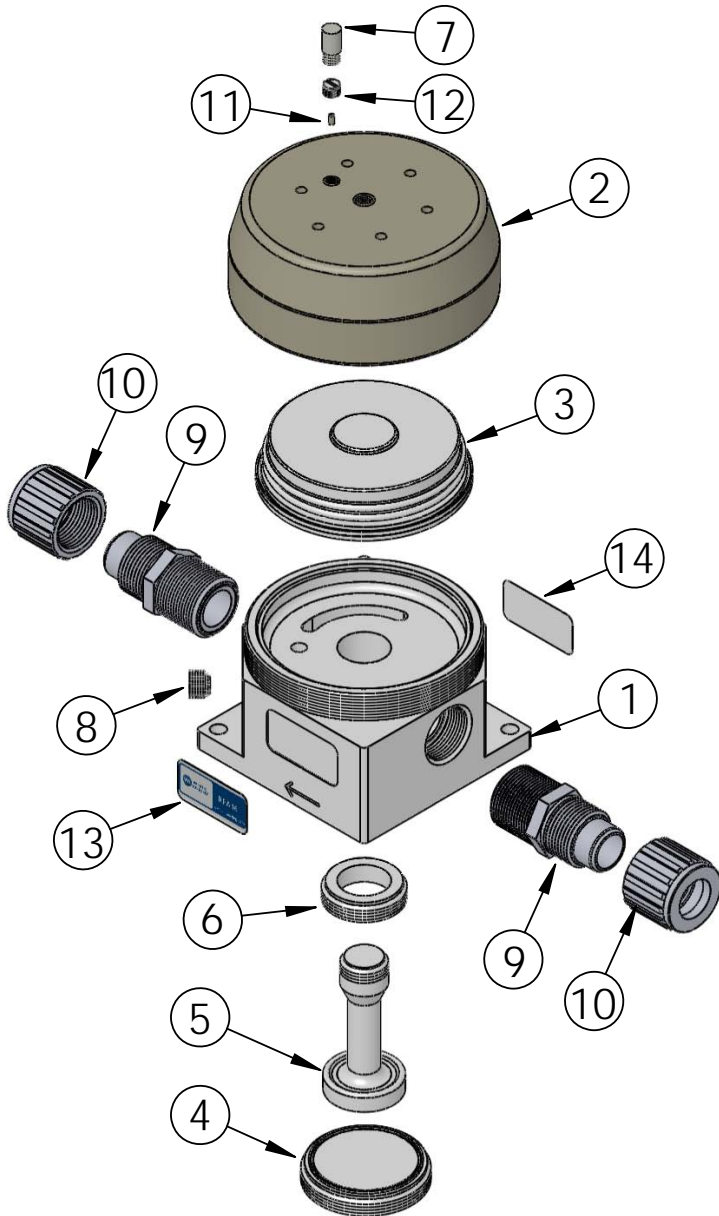





RFA16PO Exploded View

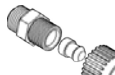

Item	Part Number	Description	Qty
1	1150-TE-0008	Body	1
2	2150-EP-0002	Head	1
3	3130-MP-0037	Bellows	1
4	4139-TE-0007	Plug	1
5	4143-TE-0008	Piston-poppet	1
6	4144-TE-0005	Seat, Poppit	1
7	6110-PP-0003	Poly Pro Muffler 1/8"	1
8	7130-TE-0006	Fluid Port Plug, 1/4"	1
9	7200-PF-0010	1" Flaretek-30gpm	2
10	7210-PF-0005	1" Flaretek Nut	2
11	10020-PK-0002	Restrictor, .016 Orifice	1
12	10040-TE-0002	1/8" NPT Plug	1
13	19100-PP-0050	Product Label	1
14	19100-PP-0120	CE Sticker	1

Fittings (Type, Size, Option)			Assemblies	Body Inlet Only (Nut not included)
 Flaretek Compatible	1/2 in.	F08	14510-PF-0011	7200-PF-0015
	3/4 in.	F12	14510-PF-0008	7200-PF-0009
	1 in.	F16	14510-PF-0009	7200-PF-0010
	1-1/4 in.	F20	14510-PF-0010	7200-PF-0011
 Tube Out	3/4 in.	T12	7120-PF-0007	
	1 in.	T16	7120-PF-0008	
	1-1/4 in.	T20	7120-PF-0009	
	1-1/2 in.	T24	7120-PF-0010	
 Weldable	3/4 in.	W12	7300-PF-0005	
	1 in.	W16	7300-PF-0006	
 Pillar S-300	1/2 in.	P08	14530-PF-0011	7400-TE-0019
	3/4 in.	P12	14530-PF-0006	7400-TE-0006
	1 in.	P16	14530-PF-0007	7400-TE-0007
	1-1/4 in.	P20	14530-PF-0008	7400-TE-0008
	1-1/2 in.	P24	14530-PF-0026	7400-TE-0035
 FNPT	3/4 in.	N12	7100-TE-0009	
	1 in.	N16	7100-TE-0005	
	1-1/4 in.	N20	7100-TE-0010	
 Synchro-Flare	1/2 in.	S08	TBD	7010-TE-0008
	3/4 in.	S12	14520-TE-0008	7010-TE-0007
	1 in.	S16	14520-TE-0007	7010-TE-0009
PrimeLock	3/4 in.	L12	14570-PF-0006	7800-TE-0006
	1 in.	L16	14570-PF-0007	7800-TE-0007
	1-1/4 in.	L20	7800-PF-0008	7800-TE-0008
Plugged		B00	7130-TE-0005	

<https://wkfluidhandling.com/pressure-regulators/>