

PPMC300 Owner's Manual



Table of Contents

1	Introduction.....	3
2	Specifications & Performance	4
2.1	Pump Specifications	4
2.2	Dimensions	4
2.3	Exploded View	5
2.4	Temperature Limitations	5
3	Pump Warranty.....	6
4	Installation and Precautions	7
4.1	Precautions	7
4.2	System and Pump Environment Recommendations/Requirements	8
4.3	Installation Advantages.....	8
4.4	Installation Instructions	9
4.5	Connections.....	10
5	Pump Control.....	11
5.1	Wire Connectors / Wire Leads.....	11
5.2	Pump Operation.....	11
5.2.1	Plug-n-Play	11
5.2.2	External Control - Analog Input.....	12
5.2.3	External Control - Digital Input.....	13
5.3	Pump Orientation.....	13
5.4	Pump Dry Priming.....	13
5.5	Pumping for Accuracy.....	14
5.6	Flow Curves	14
6	Pump Service & Rebuilds.....	15
6.1	Ordering Instructions	15
6.2	Rebuild and Maintenance	16
6.3	Rebuild Information.....	16
6.4	Return Pump to Factory.....	16
6.5	Decontamination Instructions & Certificate of Decontamination	17

1 Introduction

Thank You for Purchasing White Knight Products

You have purchased a White Knight product that has been designed to our exacting specifications and built by a team of technicians with the highest commitment to quality!

White Knight is the world leader in zero-metal, ultra high-purity pumps and continues to drive the industry with new technology and products. Since the inception of White Knight in 1995, we have been awarded over 14 US patents for our designs and have multiple other patents pending! White Knight currently produces over 30 sizes/models of pumps in varying materials to meet our customers' stringent requirements in numerous applications including ultra-high temperature re-circulation; slurry and high pressure chemical delivery systems.

White Knight has been the recipient of multiple prestigious industry awards for its designs and continues to lead the industry in quality because White Knight manufactures products from raw material to finished goods in our own facility located in Kamas, UT. This allows us to rigorously manage our quality assurance process to ensure that our strict cleanliness procedures are always followed and that components are built using consistent methods and conditions to make our products reliable and consistent.

Our strict process controls include assembling and testing our products in a class 100, temperature and humidity-controlled cleanroom. White Knight products also pass functional tests and are then dried with CDA and double bagged in the cleanroom to ensure cleanliness and operational integrity.

Before installing your White Knight product, please carefully review the product manual. There are many helpful hints and ways to optimize the set up and use of your White Knight product as well as instructions and requirements for installation. In addition, there are many accessories in this manual that will enhance the functionality of your White Knight product.

Our team has gone to great lengths to provide you with the highest quality products at the best value and we back them up with excellent warranties and world class support! We hope you agree our products will serve your exacting needs and meet your stringent requirements every time you use a White Knight Product.

Sincerely,

Steve Smith, CEO
White Knight Fluid Handling

2 Specifications & Performance

2.1 Pump Specifications

PPMC300 Pump Specifications							
Dispense Volume per Stroke ¹	Max Flow Rate	Max Discharge Pressure	Max Air Pressure	Max Cycles Per Minute	Air Consumption SCFM	Fluid Path Materials	Fluid Temperature range
~0.75 ml	300 ml/min	11 Bar (160PSI)	7 Bar (100PSI)	400	~1 SCFM	PTFE	0-100°C 32-212°F

1. Stroke length varies depending on operation

Max Dry Suction Lift ¹	Solenoid Valves	Turck Connector	On Board Controller
20 inches	2x 24V Manifold Valves 0.7 CV	5 Pin O-ring Sealed	Power: 24 VDC Max Power Consumption: 6 Watts Internal I/O: <ul style="list-style-type: none"> • Two 24 VDC Valve outputs External I/O: <ul style="list-style-type: none"> • One 0-5 VDC analog input. • Two NPN Compatible Signal Input

1. Dependent on CPM, requires min 200 CPM. Suction Lift degrades over time. Recommend install with lowest possible suction requirement

2.2 Dimensions

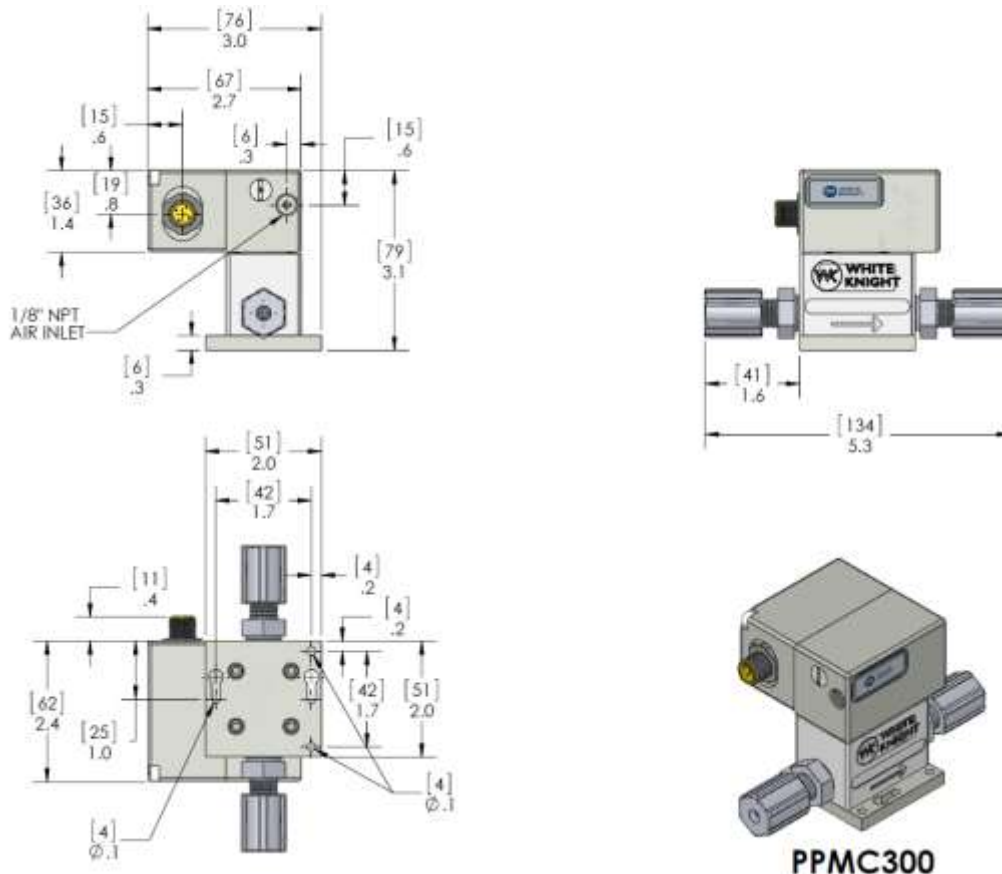

2.3 Exploded View

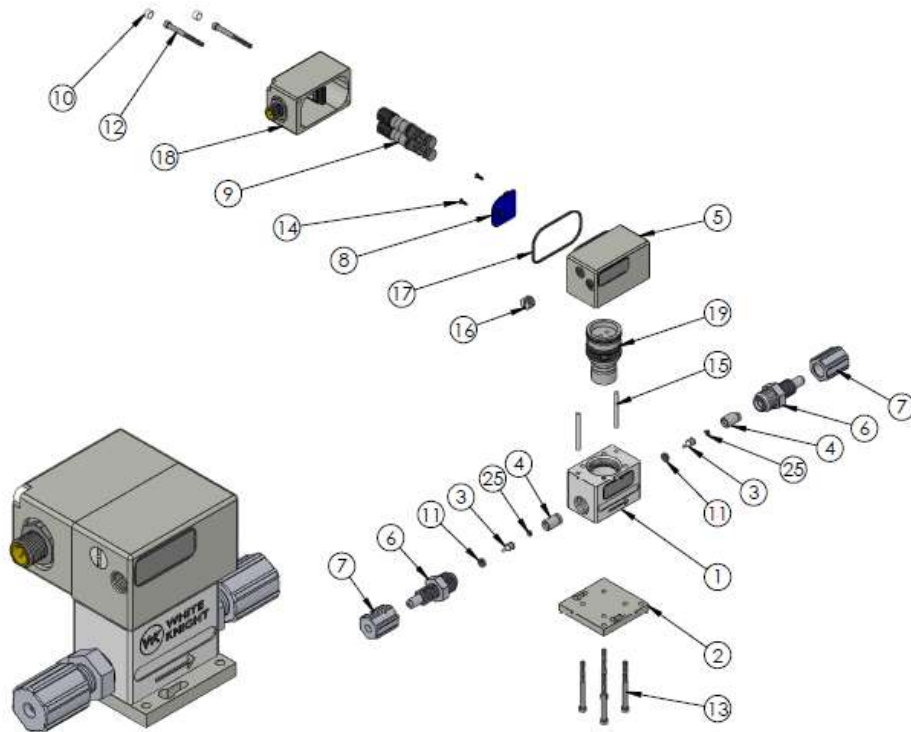

PPMC300 BILL OF MATERIALS			
ITEM NO.	PART NUMBER	DESCRIPTION	QTY
1	1125-TE-0029	BODY	1
2	1146-NP-0035	BASEPLATE	1
3	4101-MP-0007	CHECK BULLET 04WK	2
4	4142-TE-0014	CAGE CHECK, WK04	2
5	8091-NE-0014	FLYCOUSE	1
6	7200-EE-0014	1/4" FLARE/FLEX LIQUID FITTING	2
7	7200-EE-0011	NUT/FLEX/FLEX 1/4"	2
8	8500-XX-0026	BOARD ELECTRONICS	1
9	8500-XX-0028	VALVE SOLENOID BULLET	2
10	10010-NP-0008	COVER SCREW	2
11	4135-MP-0015	SEAL TIP, WK04	2
12	10010-SS-0059	SCREW L.30	2
13	10010-SS-0060	SCREW L.75	4
14	10010-SS-0063	SCREW	2
15	10020-TE-0005	PIN	2
16	10040-TE-0016	PLUG VENT, NPT, 1/8"	1
17	10080-VE-030-75	O-RING, U30	1
18	10100-NP-0017	COVER	1
19	14300-XX-0001	BELLOWS ASSEMBLY	1
20	10010-PF-0004	SPRING-FOLDED, 160 x 160 x .080	2

2.4 Temperature Limitations

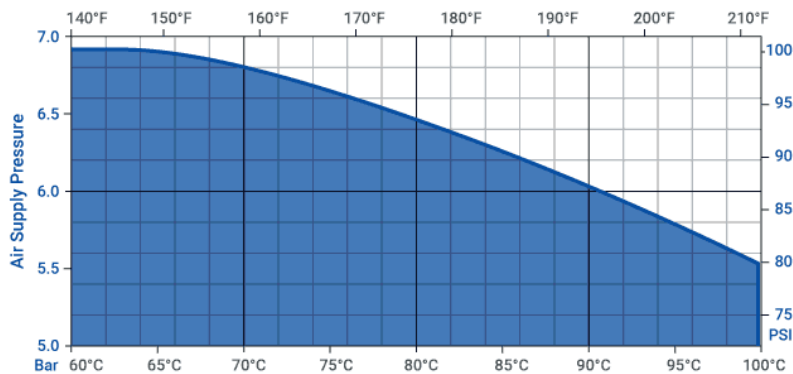

3 Pump Warranty

White Knight Fluid Handling follows strict procedures in all phases of manufacturing, assembly, and testing to ensure reliability of its products. Each pump is individually tested to assure its functional operation integrity.

White Knight Fluid Handling warrants the PPMC300 pump, subassemblies and components to be free from defects in materials and workmanship to 6 months from date of start-up, or 8 months from the date of shipment, whichever occurs first. Failures due to misuse, abuse or any unauthorized disassembly of a White Knight® pump will nullify this warranty.

The PPMC300 metering pump is warranted for up to 100 PSI air supply pressures, and 160 PSI discharge pressures. Wearable parts are not covered if used to pump abrasive slurries.

Due to the broad and ever-evolving applications for usage of White Knight® pumps we cannot guarantee the suitability of any pump component or subassembly for any particular or specific application. White Knight Fluid Handling shall not be liable for any consequential damage or expense arising from the use or misuse of its products in any application. Responsibility is limited solely to the replacement or repair of defective White Knight® pumps, components or subassemblies. All options to rebuild or replace aforementioned items shall remain under the judgment of White Knight Fluid Handling. Decisions as to the cause of failure shall be solely determined by White Knight Fluid Handling.



Prior written, faxed or emailed approval must be obtained from White Knight Fluid Handling before returning any pump component or subassembly for warranty consideration.

THE FOREGOING WARRANTY IS EXCLUSIVE AND IN LIEU OF ALL OTHER WARRANTIES EXPRESSED OR IMPLIED INCLUDING ANY WARRANTIES OF SUITABILITY FOR ANY PARTICULAR PURPOSE. NO VARIATIONS OF THIS WARRANTY BY ANYONE OTHER THAN THE PRESIDENT OF WHITE KNIGHT FLUID HANDLING IN A SELF-SIGNED AGREEMENT SHALL BE HONORED OR CONSIDERED LEGALLY BINDING.

Steve Smith, CEO
White Knight Fluid Handling

4 Installation and Precautions

4.1 Precautions

Use of Electronically Controlled Dispense Pumps	
Electrically controlled dispense pumps do not qualify for use in explosion proof environments.	
Handling	
DO NOT LIFT PUMP BY LIQUID FITTINGS OR AIR TUBING!	
Air Supply	
The operation of the PPMC300 requires a minimum of 20PSI air supply pressure, ran through a minimum 1/8" ID airline. Max air supply pressure is 100 psi. The pump operates with a pressure multiplier; discharge pressure can exceed supply pressure (100PSI supply equals up to 160PSI discharge)	
Dry Priming/Air Purging	
For optimal performance of this pump the pump should be primed with liquid until no air is found in the liquid dispense line. Mounting the pump in a vertical position, with the liquid inlet pointed down, and the liquid outlet pointed up, is recommended.	
Pumping Slurries and Abrasives	
This pump is not recommended for pumping slurries or abrasives. Pumping abrasives will shorten the life of the pump.	
Restriction of Liquid Inlet Line	
Restricting the liquid supply of the pump forces the pump to work harder than normal and should be avoided when possible.	
Cross Contamination	
PTFE and many other plastics are very porous and may retain chemicals in the pores of the material. Record chemistries used in a pump to avoid cross contamination.	
NEMA 5 Applications	
The PPMC300 is capable of NEMA 5 classification. However, this requires that the end user route the vent air to a safe location. The port is located on the front of the pump housing and is assembled and shipped with an orifice plug to allow for immediate use upon arrival. The exhaust must remain clear of obstruction, or the motor housing cover will disengage. The exhaust port is 1/8" NPT, recessed in the motor housing.	
Liquid Fittings	
The liquid fittings on this pump use tongue and groove seals and contain check valves. Over-torque of the fittings will damage the threads and reduce the performance. Because of this, the fittings are pinned in place. Rotation after initial assembly will damage the fittings. Always use a backer wrench when applying torque to fittings. Do not Disassemble These Fittings Without Prior Training From White Knight.	
WARNING: Liquids and Gasses Under Pressure	
	While in a live system, pumps contain pressurized liquids and gasses. All pressure, liquid and air must be eliminated via shut off valves before the pump may be removed or detached from the system.
WARNING: Handling of Chemicals	
	In the event that hazardous chemicals are used in or around the pump, ensure that appropriate personal protective equipment is used before handling. Reference the chemistry's Material Safety Data Sheet (MSDS) for handling instructions or other information specific to that chemical.

4.2 System and Pump Environment Recommendations/Requirements

Clean Supply Air (CDA)
White Knight high purity pumps require the use of Class 2 air for particles and moisture per ISO 8573-1. (Use 10-micron filter, maintain -40° C dew point)
Environmental Temperature
This pump is rated to withstand environmental temperatures up to 80°C.

4.3 Installation Advantages

High Discharge Pressure
The PPMC300 is capable of discharging at pressures up to 160 psi. Max air supply is 100 psi.
Mounting Orientation
The PPMC300 can be mounted in any orientation. For optimal air purge, resulting in highest repeatability, the pump should be mounted such that the fluid flows vertically.

4.4 Installation Instructions

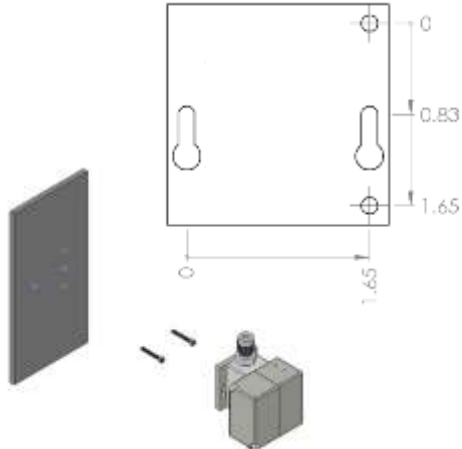
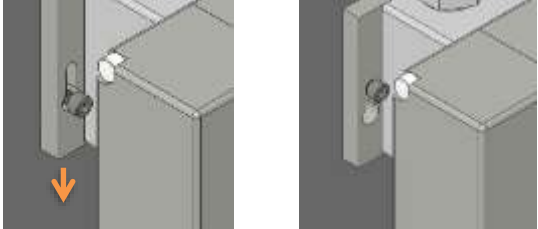
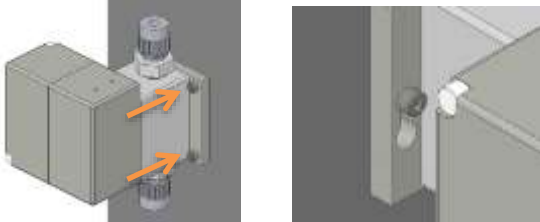
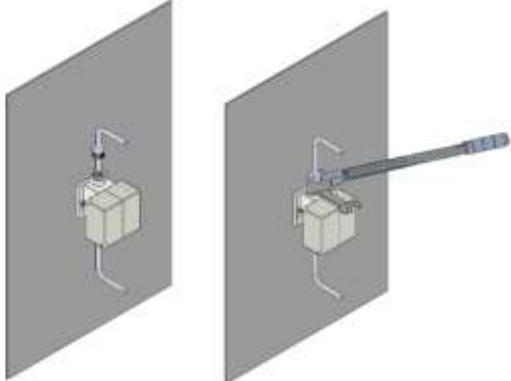
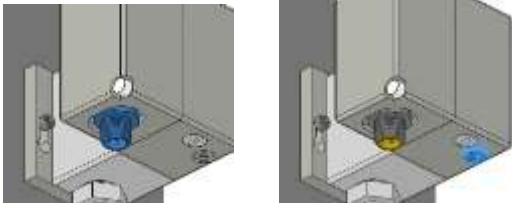
<p>Decide where the pump is to be mounted. For optimal performance mount the pump such that the fluid path flows uphill (with air and power connections pointing down as shown in the Images to the right).</p> <p>Drill and tap 3 #6-32 holes using the baseplate dimensional for positioning the holes.</p> <p>Insert #6-32 socket head cap screws into location for the key slot holes. Leave enough room for base plate to slide under screw cap; about ¼".</p>	
<p>Slide pump into position using the key slot hole to help hold pump in place.</p>	
<p>Insert and tighten the remaining 2 #6-32 socket head cap screws into position on opposite side of pump.</p> <p>Tighten the key slot screws.</p> <p>The pump is now secured.</p>	
<p>Attach liquid fittings inlet on the side with the air and electrical connections, and the outlet on the opposite side. Use a backer wrench so that the fitting is not damaged.</p>	
<p>Attach electrical connector to the M12 Turck male receptacle.</p> <p>Attach air pressure to the CDA inlet port using 1/8" FNPT port.</p>	

4.5 Connections

The pump has 5 connections:

- **Fluid Inlet Port:** This port is to be connected to the fluid reservoir that is to be pumped. Standard Flaretek and Pillar compatible options available. See ordering instructions.
- **Fluid Outlet Port:** This is the pump outlet and should be connected to where the pump is to pump the fluid. Standard Flaretek and Pillar compatible options available. See ordering instructions.
- **Exhaust Air Port:** This port is to vent the exhaust air from the pumping operation. An orifice NPT plug is connected to this port by default. If the user wants this air to exhaust to a remote location then the orifice plug can be removed and connected to a tube via the 1/8" FNPT port. Do not plug this port.
- **CDA Input:** This port is to supply the CDA input pressure. The pump will use this air pressure to pressurize the discharge liquid. The discharge liquid pressure will be 6 times the CDA input pressure. Air fitting is a 1/8" FNPT port.
- **Power & I/O Port:** This is the electrical power port that supplies power to the on-board controller and to the I/O. More information on the pin out and controls is found in section 6. Connection type male M12 5-pin receptacle made by TURCK.

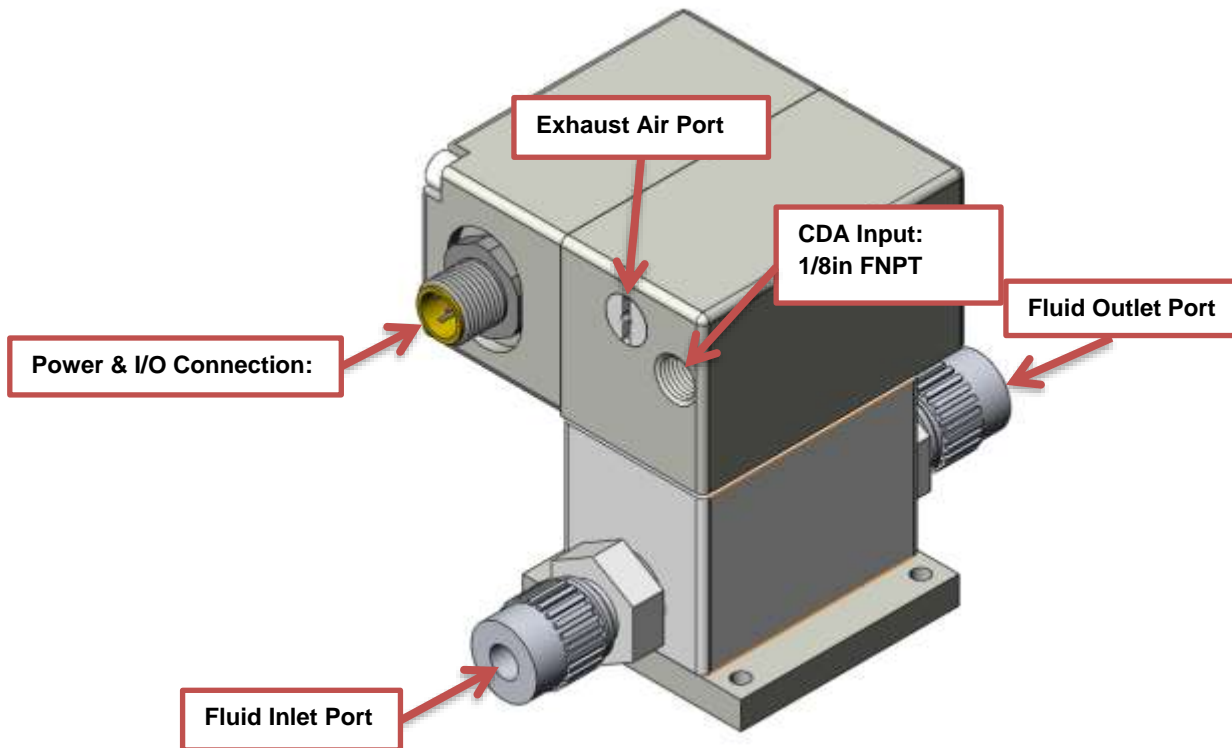

5 Pump Control

5.1 Wire Connectors / Wire Leads

The PPMC300 has Turck EuroFast male receptacle coming out of the front of the device. This connector both powers the on board controls and provides external I/O for the device. A mating cable is available and wire colors shown in the diagram relate to the optional cable.

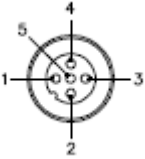
Turck Pin/ Wire Color	Function	Connection Type	Connector Diagram
1 / Brown	Power	24 VDC Power Supply	
2 / White	Analog Input	0-5 VDC Analog Input to set Cycle Rate. - 0-1 VDC = Pump Off - 1-5 VDC = Pump On = 0-400 CPM	
3 / Blue	Common Ground	0 VDC Ground, Analog Reference	
4 / Black	Valve Control Actuate Pump Suction	Sink Type Signal - 24 VDC = Not Active - 0 VDC = Active	
5 / Gray	Valve Control Actuate Pump Discharge	Sink Type Signal - 24 VDC = Not Active - 0 VDC = Active	

5.2 Pump Operation

There are several modes which the pump can operate.

- **Plug-n-Play** – This is a constant run mode, meaning that when the pump is powered on it will operate without any additional signals. This option can be ordered in one of two ways:
 - User Configurable – This means that the internal potentiometer will be preset to the specified cycle rate so that the pump will run when powered on in the initial set up of the pump by the customer. However, the user has the ability to tweak the cycle rate by adjusting the internal potentiometer.
 - Hard Coded – This means that the processor will be preprogrammed at the factory to operate at the specified cycle rate only and is not adjustable by the end user.
- **External Control** – This is an idle operation and does not start-up when powered on. When the pump is powered on then it watches for external control signals to define its operation. The external controls can be given in the following ways:
 - Analog Input – This external control uses a 0-5 VDC analog signal to define the cycle rate. The analog signal can change the operation signal from 10 to 400 CPM.
 - Digital inputs – This external control allows an external PLC to directly control the timing of the pump’s air valves, thus controlling the pump’s cycle rate.
 - Free Flow – In some cases it is advantageous to know that when the pump is idle, that there is still a forward path that is free to flow. This can help in pump priming, and in decontamination. A positively pressured supply line will open the checks and allow fluid to flow though the pump.

The following sections will go into more detail about how each of these control modes work.

5.2.1 Plug-n-Play

Working with Plug-n-Play is very easy, power the pump when you want it to pump, and remove power from the pump when you don’t want the pump to operate. The cycle rate is based off of either the factory programmed

cycle rate (which needs to be specified at the time of purchase), or from the internal potentiometer that can be accessed from inside the electrical enclosure; more details given in section 6.2.1.1. A device that was not previously set in Plug-n-Play operation can be modified to operate to perform in this manner, and if a pump was set in plug-n-play, if it was not hard coded, can be modified to accept external controls.

5.2.1.1 Switching Between Plug-n-Play and External Control:

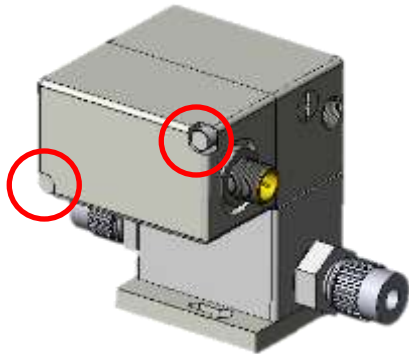

To switch the electrical remove the and the two cover in Once the surface board right).

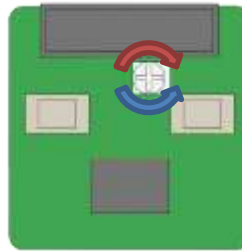

the operation mode of the PPMC300, cover will need to be removed. To cover remove the cap screw covers cap screws the hold the electrical place (shown in image to the left). cover has been removed then find the mount potentiometer on the circuit

(Shown on image to the Use a small Philips head screwdriver and rotate the potentiometer to the desired

position.

The potentiometer has 270° of rotation. the cycle rate down, and rotating counter rate up. If the potentiometer is rotated all direction then the pump will stop cycling control signals to operate the pump. See visual of how the cycle rate corresponds to the clockwise and counterclockwise

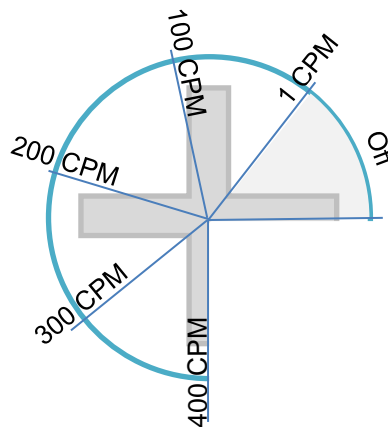

Rotating clockwise will slow clockwise will speed the cycle the way in the clockwise and will wait for external diagram on the right for a the amount rotation relative rotation limits.

Note: the potentiometer can be adjusted while the power is on, to assist in properly tuning the cycle rate; however, care should be taken to not short circuit the circuitry.

After the potentiometer is set in either the Plug-n-Play operation, or in External Control operation then the electrical cover should be replaced being careful to not pinch any wires. Tighten the socket head screw caps until they are snug; do not over tighten, as this could strip out the plastic housing. Replace the screw cap covers.

5.2.2 External Control - Analog Input

With the Plug-n-Play control disabled, then the pump is in external control. At this point the imbedded controller watches its analog input and will vary its cycle rate depending on the signal received. Analog input signal is 0-5 VDC with the common ground from the power input is the reference voltage for the analog input signal. The analog input is interpreted as follows:

- 0-1 VDC: Pump will not operate.
- 1 VDC: is the transition from on to off, and should be avoided as a signal input, as the pump may toggle between the on and off position and will not flow.
- 1-5 VDC: Pump will operate based upon the voltage to cycle rate conversion equation below.
 - $CycleRate = 100 * VoltageInput - 100$
 - This equation outputs a linear cycle rate output below are some example voltage to cycle rates:
 - 1.1 VDC = 10 CPM
 - 2 VDC = 100 CPM
 - 3 VDC = 200 CPM
 - 4 VDC = 300 CPM
 - 5 VDC = 400 CPM

5.2.3 External Control - Digital Input

With the Plug-n-Play disabled, the pump requires external control signals. In digital input control method, the user has the most flexibility in operating the pump. The user specifies a faster and slower cycle rate by directly controlling the timing of the valves. There are two digital inputs that connect to the internal air valves. One is tied to the pistons' up stroke and the other is tied to the down stroke. The pump works by oscillating the up stroke and the down stroke signals opposite of each other. The digital signals work with NPN or Sink type digital connections.

An example digital control signal is shown below:

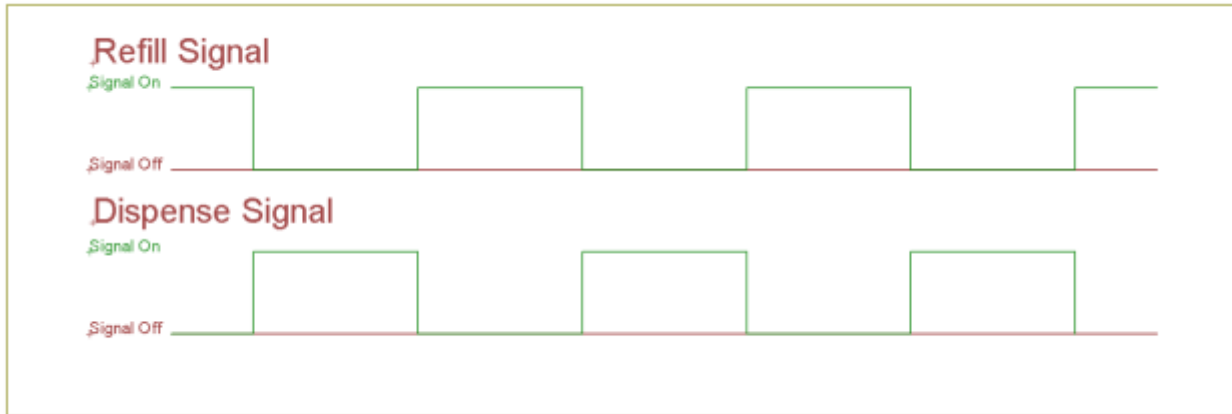

Note: The CPT-1 is a pump controller offered by White Knight and is capable of operating the PPMC300 in digital control mode.

5.3 Pump Orientation

This pump uses spring loaded checks which enables the pump to be oriented in any direction. This provides design flexibility allowing it to be mounted anywhere. While the pump can be mounted in any direction and function, there is still a preferred mounting orientation. This pump prefers to be mounted such that the flow path travels up hill; this allows for air bubbles that might travel in the line to have a free path to exit the pump and be more repeatable.

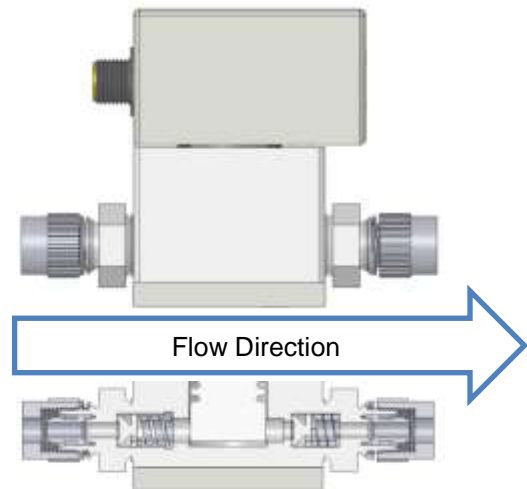

5.4 Pump Dry Priming

Because of the small size of this pump, it has a limited dry prime capability of approximately 20". Dry prime functions optimally between 200-400 CPM, and with 80 PSI air pressure. Once the pump is primed then much higher suction lift is available.

For applications that require higher suction lift a DI water purge can be used to prime the pump. To perform a DI water purge, connect a pressurized DI line to the pump inlet, let the water run till you see fluid coming out the outlet, then switch back to the source tank. This can be done by placing a 3-way valve on the inlet line; then the user could switch between the DI water and the supply tank.

5.5 Pumping for Accuracy

This pump is designed as a device that creates backpressure to move chemistry from one location to another. Some customers may want to use this device for dosing or for more precision pumping applications. In order to achieve the higher accuracy required for pumping for dosing type applications it is recommended to pump through an orifice or into a line with some back pressure. Adding back pressure on the pump's outlet makes the pump perform more repeatable and reduces wear on the checks, which will give a more constant performance over the life of the pump. When the outlet is restricted, then the flow will be analogous to a pressurized line flowing through a known orifice, resulting in a more stable flow.

5.6 Flow Curves

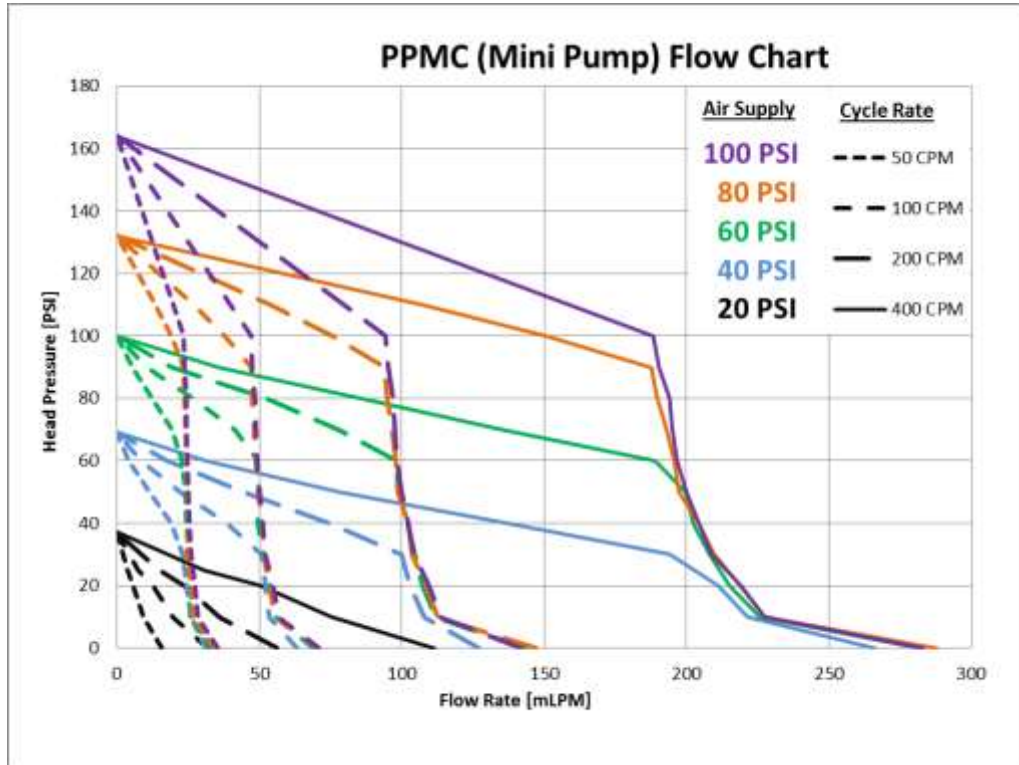

*300 mL/min at wide open flow path. The Flow Chart measurements shown are using a back-pressure regulator to simulate a pressurized system; results may vary.

6 Pump Service & Rebuilds

6.1 Ordering Instructions

Wkfluidhandling.com/ordering-instructions

White Knight Fluid Handling

PPMC300 Ordering Instructions

Required Configurations									
PPMC300	CD	-	F	04	E3	-	C1	-	001
	①		②	③	④		⑤		⑥

Bold = standard option

Please select one option from each of the required fields (1 - 3).

① Liquid Valve Options

① Liquid Valve Type	
CD	= Spring Loaded Disk Valves

② ③ Fitting Style and Size

② Fitting Style		③ Fitting Size	
F	= Flaretek® compatible* <small>*Not available in 1/8"</small>	02	= 1/8"
P	= Pillar S-300®	04	= 1/4"
		06	= 3/8"

④ Electrical Connection

E3	= Turk Connector (Without Cable)
E1	= 15' PVC Jacketed Cable

⑤ Cycle Rate Control

C1	= Communication Based/Potentiometer	*If Option C2 is chosen, option 6 must be added.
C2*	= Hard Programmed*	

⑥ Cycle Rate (Used With Option C2 Only)

001**	= Cycle Rate (Cycles Per Minute)**	**Enter value between 000 and 400 - represents cycles per minute
-------	------------------------------------	--

White Knight Fluid Handling, Inc.

www.wkfluidhandling.com

435-783-6040

Please contact White Knight for orders requiring Copy Exact.

6.2 Rebuild and Maintenance

Rebuild Parts for PPMC300 Pump

Part Number	Description	Quantity
8600-XX-0028	Solenoid Valves	2
14300-XX-0001	Bellows Assembly	1
7200-PF-0014 ¹	1/4in Flaretek Comp. Liquid Connection	2
10010-PF-0003	Check Spring	2
4135-MP-0012	Check Seat	1
4101-TE-0001	Disk Check	2
10080-VI-030-75	O-Ring	1
8600-XX-0026	Controller	1
10020-TE-0005	Pin	2

1. Part referenced is the check cage, as well as the liquid connection for 1/4in flaretek compatible fittings. For alternate liquid connections, contact White Knight at customer.support@wkfluidhandling.com.

Location of Rebuild Site

Due to the nature of the PPMC300 metering pumps, rebuilds of the PPMC must be performed at White Knights facility. White Knight reserves the right to refuse a rebuild request.

6.3 Rebuild Information

Pumps requiring service under warranty must be returned to White Knight for warranty coverage. Options for out-of-warranty pumps are listed below in order of recommendation.

1. Return the pump to White Knight for a full evaluation, failure analysis, and quote issued by White Knight or our local distributor. Upon the acceptance of the quote in the form of a purchase order the pump will be rebuilt as outlined in the quote. Pumps that undergo a full rebuild will be returned with a full renewal of its original warranty.

6.4 Return Pump to Factory

1. After removing the pump from the station, the pump must be flushed as described in the “Attention” section of this document, decontamination instructions and certificate of decontamination in section 6.4.
2. Remaining DI water in the pump should be drained from the inlet and outlet liquid tubing connectors.
3. The pump liquid outlets must then be plugged per manufactures instructions
4. Dry the pump.
5. Double-bag the pump - **sealing it** in thick polyethylene bags.
6. Return the pump to its original packaging.
7. Include Material Safety Data Sheet (hereafter MSDS) in the box with the pump for any chemical to which the pump was exposed.
8. Obtain RMA number from White Knight, and write it on the outside of the box.
(<https://wkfluidhandling.com/support/rma/>)
9. Ship to White Knight following all rules, regulations and laws regarding the shipping of dangerous materials. Ship freight pre-paid. No collect or COO shipments will be accepted. Unauthorized use of White Knight shipping accounts will result in additional freight costs to the bill as well as a service charge. Follow all shipping instructions in reference to sending your pump to its appropriate suite.

6.5 Decontamination Instructions & Certificate of Decontamination

Attention:

White Knight products are designed for use with caustic and otherwise dangerous liquids. Therefore, every product must be handled as if it contains dangerous chemicals. White Knight specifies that if a pump runs under its own power, the pump should circulate DI water for twenty minutes before disassembly or double-bagging for shipment. If the pump does not run under its own power, then DI water should be forced from the inlet, through the outlet for 40 minutes before disassembly or double-bagging for shipment. Only those who have been adequately trained in safety with the handling of acids and other dangerous chemicals should attempt to handle a White Knight pump that has been exposed to dangerous chemicals. Adequate safety gear appropriate for the chemical that has been in the pump must be used and no attempt should be made to handle the pump until MSDS for the chemical that the pump has been used in have been reviewed. Ph papers, showers, antidotes, clean-up equipment, neutralizers, and any other safety devices that could be used for detecting, neutralizing or minimizing effects from the chemical described in the appropriate MSDS must be present along with emergency numbers for use in the event of an accident. Take care in the handling of liquids and/or residues contained in these pumps or any other chemical handling equipment. Remember, **Safety First**.

Note:

Any pumps returned to White Knight for warranty evaluation or repair must be complete with all parts and components including but not limited to tubing connectors, tubing connector caps, flare noses and tubing. Any missing parts will be added to the pump and charged to the customer in the event of repair or replacement, warranty or otherwise.

Return Material Authorization requests may be filed online here:

<https://wkfluidhandling.com/support/rma/>

Removal of Pump from Station:

1. Disconnect air supply from the pump.
2. Disconnect liquid lines.
3. Plug liquid fittings per manufactures instructions or plug the pump inlet/outlet ports with a White Knight buttress plug.
4. Remove the pump from its base plate.
5. Return all removed parts with the pump.



187 E. 670 S., Kamas, UT 84036
435.783.6040 888.796.2476
<https://wkfluidhandling.com>

RMA Request Form

COMPLETE AND RETURN THIS FORM TO WHITE KNIGHT FOR RMA QUOTE AND INSTRUCTIONS.
Mail completed form to: 187 E. 670 S., Kamas, UT 84036 or email to: customer.support@wkfluidhandling.com.
RMA requests can also be made online at <https://wkfluidhandling.com/support/rma/>.

I, the undersigned employee of _____,
request a return merchandise authorization (RMA) for the product listed below.

Serial#: _____
(We cannot process returns without a product serial number.)

Product used with:
 Copper
 Other Metal(s)
 No Metal(s)

Reason for Return:
(Check all that apply.)

- Standard Evaluation *(See Purchase Order)*
- Return of Demo Product
- Maintenance or Service Repairs
- Exchange Product

Product has problem:

(Check all that apply or write in other problems and/or details if necessary)

- Air Leak
- Fluid Leak
- Low/No Flow
- Non-Functional
- Erratic Operation
- Bellows Failure
- Check Failure
- Cycle Failure
- Shuttle Failure
- Shaft/Seal Failure
- Other: _____

Failure Details: _____

Purchase Order: _____
(For standard evaluation returns, please provide a Purchase Order for \$200. If service is needed, this payment will be applied to the service.)

Air Supply Pressure: _____ *(Max or range in PSI or Bar. e.g. 80 PSI, or 80-90 PSI)*

Flow Rate: _____ *(Max or range in LPM or GPM)*

Process Chemistry: _____ *(e.g. HF, HCl, H2O2, etc.)*

Process Metals: _____ *(e.g. Cu, Au, Ba, Cd, Co, Ga, Ni, No, Pb, Pt, etc.)*

Process Temperature: _____ *(Max or range in °F or °C)*

Duty Cycle: _____ *(Max or range in PSI or Bar. e.g. 80 PSI, or 80-90 PSI)*

Product Installation Date: _____ *(Date of product installation)*

Additional Information: _____

Name: _____

Phone: _____

Email: _____

Signature: _____

Date: _____



Barclay-Phelps

CE MARKING SPECIALISTS
Hoi Yuen Road, Kwun Tong, Kowloon, Hong Kong

CERTIFICATE & DECLARATION OF CONFORMITY FOR CE MARKING

Company contact details:

White Knight Fluid Handling Inc.
187 E. 670 S., Kamas, Utah, 84036, USA

White Knight Fluid Handling Inc. declares that their:

Bellows Pump Line

PSA030, PSA060, PSA140, PSH030, PSH060, PSH140, PSU030, PSU060, PSU140, PSA025, PSA050, PFA030, PFA060, PFA140, PFH030, PFH060, PFH140, PFU030, PFU060, PFU140, PXA030, PXA060, PXA140, PXH030, PXH060, PXH140, PXJ030, PXJ060, PXJ140

Diaphragm Pump Line (Non Conductive)

PSD04TE, PSD06TE, PSD08TE, PSD16TE, PSD24TE, PSD04UH, PSD06UH, PSD08UH, PSD16UH, PSD24UH

Diaphragm Pump Line (Conductive)

PSD04TC, PSD06TC, PSD08TC, PSD16TC, PSD24TC, PSD04UC, PSD06UC, PSD08UC, PSD16UC, PSD24UC

Legacy Pump Line

PLS30, PLS60, PLS120, PLX30, PLX60, PLX120, PX30, PX60, PX120, PLF30, PLF60, PLF120

Metering Pumps

PPM100, PEM100, PEM050

Plastic Pumps

PHC40-2, PPMC300

are classified within the following EU Directives as applicable:

Machinery Directive 2006/42/EC
Low Voltage Directive 2014/35/EU
Electromagnetic Compatibility Directive 2014/30/EU
RoHS 2 Directive 2011/65/EU

and further conform with the following EU Harmonized Standards as applicable:

EN 809:1998+A1:2009 EN 60204-1:2006 + A1:2009 EN 61000-6-2:2005 EN 61000-6-4:2007+A1:2011

Dated: 16 January 2017

Position of signatory: Product Manager **Name of Signatory:** Cory Ammon Simmons

Signed below: on behalf of White Knight Fluid Handling Inc.

